

TOS9200 SERIES

Hipot and Insulation Resistance Tester

Perfect design for System Operation, introducing our top of the line of Hipot / Insulation Resistance Testers



TOS9201(AC/DC)
TOS9200(AC)



Capable of performing hipot and insulation testing in compliance with safety standards, including IEC, EN, VDE, BS, UL, CSA, JIS and the Electrical Application and Material Safety Law (Japan)

The TOS9200 Series has been developed to meet a wide diversity of customer needs. Including the refinement and enforcement of Kikusui's former series, its specifications reflect the results of detailed study of our large database of user's requirements including special orders and modifying specifications.

The TOS9200 Series consists of four products : the testers TOS9200 and TOS9201, and the high-voltage scanners TOS9221 and TOS9220. The TOS9200 is equipped with AC hipot and insulation resistance testing functions, while the TOS9201 has a DC hipot testing function in addition to these two functions. The power block, a core component, employs a high-efficiency switching power supply and a switching amplifier based on PWM systems. These features realize high power and enhanced stability, as well as reducing the size and weight of the unit. When combined with the ground bond tester TOS6200, the TOS9200 Series integrates three or four types of tests in a single process.

Furthermore, when used together with the high-voltage scanner TOS9220/9221 (equipped with a contact check function), the tester is capable of automatically checking test points for up to 16 channels, thereby facilitating a safe, reliable automatic testing system.

- Rise-time control function
- Fall-time control function
- Offset cancel function
- Measured-value hold function
- Output voltage monitoring function
- Memory function
- Program function
- Interlock function
- DC discharge function

TOS9200 SERIES

Hipot and Insulation Resistance Tester

Basic performance

Three functions - AC hipot testing, DC hipot testing and insulation resistance testing

The TOS9200 can perform AC hipot tests and insulation resistance tests, while the TOS9201 can also conduct DC withstanding tests. Once connected to a device being tested, the TOS9201 executes an AC hipot test, DC hipot test, and insulation resistance testing in succession in one process.

AC hipot testing at 5 kV and 100 mA

Equipped with a high-efficiency switching power supply in its high-voltage power block, a PWM-based switching amplifier and a 500 VA high-voltage transformer, the TOS9200/TOS9201 realizes a maximum output of 5 kV/100 mA (continuous output for 30 minutes), or 2.5 times the output of Kikusui's former models. At a test voltage of 500 V or more and an upper current of 100 mA, or greater the tester instantaneously satisfies the requirements of a short-circuit current of 200 mA or more which is required by the IEC standard *. In addition, the tester ensures a load effects of 30% or less and the generation of a consistent 50 Hz/60 Hz test voltage free from the affect of the supply voltage. These features eliminate the need to readjust the output voltage once the test voltage is preset.

*Continuous outputs are impossible because the output is cut off if an overcurrent is detected.

DC hipot testing at 6 kV and a maximum output of 50 W

The TOS9201 permits DC hipot testing at up to 6 kV *. The tester is equipped with a stable, low-ripple DC/DC converter with a load factor of 1% or less.

*Maximum output of 50 W for up to 1 minute.

Insulation resistance testing at 25 V to 1000 V and 0.01 MΩ to 9.99 GΩ

The test voltage can be set to 25 V through 1000 V at a resolution of 1 V. Insulation resistance covers a wide measurement range from 0.01 MΩ to 9.99 GΩ *.

Test voltage	Resistance measurement range
25V	0.03 MΩ to 500 MΩ
50V	0.05 MΩ to 1.00 GΩ
100V	0.10 MΩ to 2.00 GΩ
125V	0.13 MΩ to 2.50 GΩ
250V	0.25 MΩ to 5.00 GΩ
500V	0.50 MΩ to 9.99 GΩ
1000V	1.00 MΩ to 9.99 GΩ

A single unit of the TOS9200/9201 is capable of handling

all test voltages required by JIS C 1302 1994 (Insulation Resistor Meter) and fully meets the JIS requirements.

*At a maximum rated current of 1 mA to 50 nA.

Enhanced measurement accuracy

The TOS9200/9201 is provided with a digital voltmeter for hipot testing at an accuracy of $\pm(1\% \text{ of reading} + 30 \text{ V})$ and another one for insulation resistance testing at an accuracy of $\pm(1\% \text{ of reading} + 1 \text{ V})$. Measured values are displayed not only during a test, but while a program is being executed. A digital ammeter with an accuracy of $\pm(3\% \text{ of reading} + 20 \mu\text{A})$ is also provided for hipot testing. Kikusui's predecessors had the highest measurement resolution of about 1 mA, with an accuracy of $\pm 5\%$ of the upper cutoff current when it is set to 100 mA. In contrast, the digital ammeter allows the TOS9200/9201 to make measurements at an accuracy of $\pm(3\% \text{ of reading} + 20 \mu\text{A})$, even if the upper current is set to 100 mA. The ammeter displays measured values while the program executes, as well as during an AC or DC hipot test.

Type	Display accuracy
Voltmeter for hipot testing	$\pm (1\% \text{ of reading} + 30\text{V})$
Ammeter for hipot testing	$\pm (3\% \text{ of reading} + 20\mu\text{A})$
Voltmeter for insulation resistance testing	$\pm (1\% \text{ of reading} + 1\text{V})$
Insulation resistance meter	$\pm (2\% \text{ of reading})^*$

*At $1 \mu\text{A} < \text{measured current} \leq 1 \text{ mA}$



TOS9200 SERIES

Hipot and Insulation Resistance Tester

Diverse functions

Rise-time control function

In AC hipot testing, DC hipot testing and insulation resistance testing, you can apply a voltage gradually to reach the test voltage, instead of applying the test voltage directly at the start of a test. The voltage increase time can be set to 0.1 s through 99.9 s at a resolution of 0.1 s, and to 100 s to 200 s at a resolution of 1 s. The start voltage is also adjustable between 0% and 99% at a resolution of 1%.

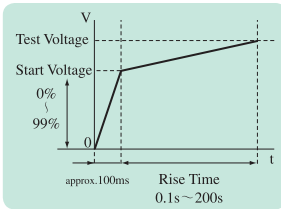

Fall-time control function

In AC hipot testing, you can gradually decrease the test voltage after a PASS judgment. The voltage fall time is adjustable between 0.0 s and 99.9 s at a resolution of 0.1 s, and between 100 s and 200 s at a resolution of 1 s.

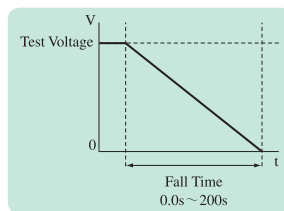

Offset cancel function

In AC hipot tests that require high sensitivity and high voltages, currents flowing into the stray capacity of the test lead wire, jigs, and other components can cause measurement errors. The TOS9200/9201 features a function to cancel these offset currents.

Voltage hold function

During measurement, this function allows you to hold the value of the voltage measured at the end of an AC or DC hipot test, as long as the test results are being displayed. When combined with the rise-time control function, this function enables to observe the insulation breakdown voltage.

Maximum Leakage current and minimum resistance hold function

By selecting "MIN/MAX Mode" in the measurement mode settings, you can hold the maximum current in hipot testing and the minimum resistance after the judgment wait time in insulation resistance testing. These values are shown on the tester's display. They can also be read back via interface (GPIB or RS-232C).

Output voltage monitoring function

When the output voltage deviates from $\pm(10\%$ of setting + 50 V), the monitoring function activates to suspend the test, thus ensuring highly reliable testing.

Current detection response speed adjustment function

This function switches current detection response speeds for UPPER judgment by adjusting the integrated time constant of the current detection circuit. Three modes are available for the integrated time constant: SLOW (about 40 ms), MID (about 4 ms) and FAST (about 0.4 ms). SLOW mode is used in normal operations. MID and FAST modes are more effective in detecting a discharge occurring instantaneously or containing a large number of frequency components. They are also useful for hipot tests of test devices that insulation likely be breakdown, such as small electronic components.

Memory function

Up to 100 test conditions used in AC and DC hipot testing and insulation resistance testing, such as the test voltage, judgment value and test time, can be stored with a specific name. For instance, you can store the name of an applied safety standard and the destination of the product to be tested. If test conditions are preset, operator can recall relevant test conditions simply by entering the memory number. If you previously assigned a special name to each of these test conditions, operator can check recalled test conditions by name. The memory function allows you to recall test conditions not only through the recall operation on the front panel, but also by remote control.

[Storable test conditions]

	AC withstanding voltage testing	DC withstanding voltage testing	Insulation resistance testing
Test voltage	✓	✓	✓
Test frequency	✓		
Lower cutoff value	✓	✓	✓
ON/OFF of the lower judgment function	✓	✓	✓
Upper cutoff value	✓	✓	✓
ON/OFF of the upper judgment function			✓
ON/OFF of the offset function	✓		
Test time and ON/OFF of the timer function	✓	✓	✓
Start voltage	✓	✓	
Voltage rise time	✓	✓	✓
Voltage fall time	✓		
Judgment wait time		✓	✓
Test voltage range	✓		
SLOW/MID/FAST settings for the response filter	✓		
FLOAT/GND of the LOW terminal	✓	✓	✓
HIGH/LOW/OPEN settings for the scanner channel	✓	✓	✓
ON/OFF of the contact check function	✓	✓	✓

Program function

By coordinating test conditions stored in an AC hipot test, DC hipot test, and insulation resistance test, operator can sequentially run tests that comprise up to 100 steps. When used together with the ground bond tester TOS6200/6210, the TOS9200 Series permits continuous tests combining test conditions stored in the TOS6200, as well as on the TOS9200 itself. Sequential tests are possible, for example, on AC hipot, insulation resistance, DC hipot, and ground bond, in order. The TOS9200 Series stores up to 500 steps and 100 programs, which can be recalled through the recall operation on the front panel or by remote control.

[Sample program]

Step 00		Step 01		Step 02		END
Memory	Interval	Memory	Interval	Memory	Interval	
ACW01	0.2s	DCW01	0.2s	IR01	0.2s	

At Step 00, Step 01 and Step 02, memory ACW01 (AC hipot test), DCW (DC hipot test: TOS9201 only) and IR01 (insulation resistance test) are performed, receptively, in succession at 0.2-second intervals.

TOS9200 SERIES

Hipot and Insulation Resistance Tester

Interfaces

REMOTE connector & SIGNAL I/O connector

The REMOTE connector on the front panel is intended exclusively for Kikusui's options (remote control/ test probe). It allows start and stop operations by remote control. The SIGNAL I/O connector on the rear panel permits operator to recall panel memory and program memory contents by remote control, as well as controlling start and stop operations. Seven different signals are output from the SIGNAL I/O connector through the open collector.



[SIGNAL I/O]

No.	Signal name	I/O	Details of signal
1	PM0	I	LSB, LSD *1
2	PM1	I	LSD *1
3	PM2	I	LSD *1
4	PM3	I	LSD *1
5	PM4	I	MSD *1
6	PM5	I	MSD *1
7	PM6	I	MSD *1
8	PM7	I	MSB, MSD *1
9	STB	I	Input terminal for the strobe signal of the panel memory and program memory
10	MODE0	I	Selects a test mode *2
11	MODE1	I	Selects a test mode *2
12	NC		
13	COM		Circuit common (chassis potential)
14	H.V ON	O	ON during a test and an automatic test (AUTO) or while a voltage remains between the output terminals
15	TEST	O	ON during a test (except for voltage rise and voltage fall)
16	PASS	O	ON during the time preset in the PASS HOLD settings when a PASS judgement is made
17	U FAUL	O	Continuously ON in an UPPER FAIL judgement. Continuously ON in a CONTACT FAIL judgement with the scanner connected.
18	L FAUL	O	Continuously ON in a LOWER FAIL judgement. Continuously ON in a CONTACT FAIL judgement with the scanner connected.
19	READY	O	ON during the READY status
20	PROTECTION	O	ON when the PROTECTION function is activated
21	START	I	Input terminal for the START signal
22	STOP	I	Input terminal for the STOP signal
23	ENABLE	I	Input terminal for the ENABLE signal for the START signal
24	+24V		Output terminal for +24 V internal power, with a maximum output current of 100 mA
25	COM		Circuit common (chassis potential)

[Pin Configuration for the SIGNAL I/O Connector]



- Input signal [Low active control input High-level input voltage: 11 V to 15 V / Low-level input voltage: 0 V to 4 V / Low-level input current: Maximum -5 mA / Input interval: Minimum 5 ms]
- Output signal [Open collector output (DC4.5V to 30V) / hipot: DC 30 V / Output saturation voltage : Approximately 1.1 V (25 °C) /Maximum output current : 400 mA (TOTAL)]
- * The input signal circuit is pulled up to +12V. Therefore, opening the input terminal is equivalent to inputting a high-level signal.
- *1 2-digit BCD low active input Signal input terminal for selection between the panel memory for ACW, DCW, and IR, and the program memory for AUTO Memory recall by latching this selection signal at the rise of the strobe signal
- *2 2-bit low active input

Test mode	ACW	DCW	IR	AUTO
MODE0	H	L	H	L
MODE1	H	H	L	L

GPIB/RS-232C interface

A GPIB/RS-232C interface is provided as a standard feature to facilitate the remote control of all functions of the TOS9200/9201 except the POWER switch, the KEYLOCK function, and the program execution (AUTO) function.



RS-232C [Baud rate: 9600/19200/38400 bps/TOS6200/6210 interface (AUTO mode only): START/STOP control, test condition settings, reading of TOS6200/6210 measured values, and measurement results]

GPIB [Remote control of all functions except the POWER switch, the KEYLOCK function, and the program execution (AUTO) function/SH1, AH1, T6, TE0, L4, LE0, SR1, RL1, PP0, DC1, DT0, C0, E1]

Peripheral devices

High-voltage scanner TOS9220/TOS9221

TOS9221 Front View (same for TOS9220)



TOS9221

TOS9220



The high-voltage scanner TOS9220/TOS9221 has a function that distributes the test voltage provided by the TOS9200/9201 to multiple test points. Up to four channels can be used for outputs on this scanner. Each channel can be set to one of the three electric potential modes – HIGH, LOW, or OPEN. Operator can conduct AC/DC hipot and insulation resistance tests on any of the four test points. Furthermore, up to four scanners can be connected to the tester, allowing a maximum of 16 channels. The TOS9200 is equipped with a “contact check function” to check the contact between the output of each channel and a test point. These features ensure highly reliable and labor-saving hipot and insulation resistance tests for electrical and electronic equipment with multiple test points.

*Pictures below are showing rear views of the units with cable clamp of output terminal removed.

TOS9221 Rear View



TOS9220 Rear View



Operation of the high-voltage scanner

On the TOS9200/TOS9201, you can select an electric potential mode for each channel—HIGH(high voltage side), LOW (low voltage side), and OPEN (open mode). The high-voltage scanner permits AC/DC hipot or insulation resistance tests on any of the four test points A to D. For instance, you can set CH1 (test point A) to HIGH, CH2 (test point B) to OPEN, and CH3 (test point C) to LOW, and CH4 (test point D) to LOW. To specify these settings, you can use the TOS9200/9201 panel or the GPIB/RS-232C.

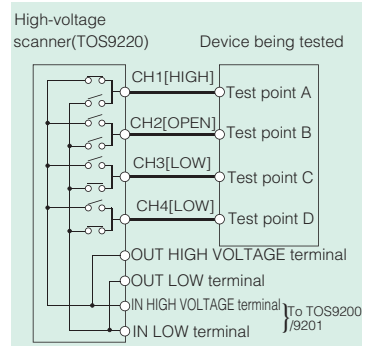

TOS9200 SERIES

Hipot and Insulation Resistance Tester

For Stand alone use...

Example of system for applying voltage by Test Lead or start/stop operation by Remote Control Box.

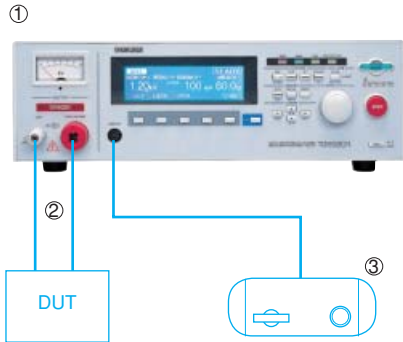

Item	Model	cable length	Required numbers
① Hipot / Insulation Resistance Tester AC/DC	TOS9201		1 pc.
② High-Voltage Test Lead	TL01-TOS	1.5m *1	1 set
③ Remote Control Box	RC01-TOS *2	1.5m	1 pc.

*1: Also available for 3m cable, TL02-TOS

*2: Also available for both-hands operation, RC02-TOS

Example of system for applying voltage or start/stop operation by High-Voltage Test Probe.

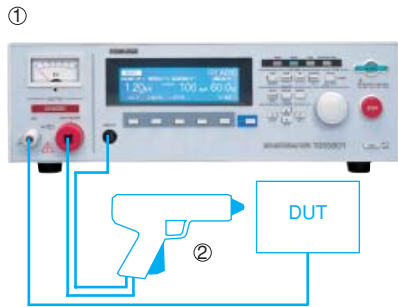

Item	Model	cable length	Required numbers
① Hipot / Insulation Resistance Tester AC/DC	TOS9201		1 pc.
② High-Voltage Test Lead	HP01A-TOS	1.5m *1	1 pc.

*1: Also available for 3m cable, HP02A-TOS

For Multiple Channel Testing by High Voltage Scanner...

Example of system consisting TOS9201 and TOS9221 X 2sets (8CH)

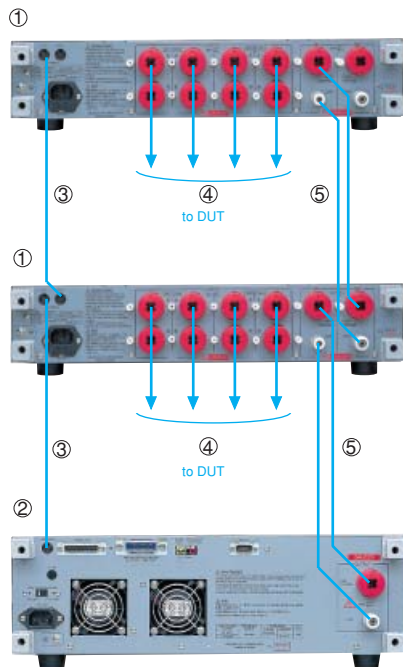

Item	Model	cable length	Required numbers
① High-Voltage Scanner	TOS9221		2 pc.
② Hipot / Insulation Resistance Tester AC/DC	TOS9201		1 pc.
③ Interface cable	85-50-0210	0.5m *1	2 pc.
④ High-Voltage Test Lead (red)	TL07-TOS	1.5m	8 pc.
⑤ High-Voltage Leads for Parallel connection	TL06-TOS	0.5m *2	2 set

*1: Also available for 2m cable, DD2M-8P

*2: Also available for 1.5m cable, TL04-TOS

[Rack mount bracket]

TOS9200 / 9201	(JIS)	KRB150-TOS
	(EIA)	KRB3-TOS
TOS9220 / 9221	(JIS)	KRB100-TOS
	(EIA)	KRB2-TOS

[CAUTION] In case of using more than 2sets of High Voltage Scanner, it is required to rack mount or locate these units to the side of Hipot / Insulation Resistance Tester, and it should not be piled up more than 2sets of High Voltage Scanner units.

TOS9200 SERIES

Hipot and Insulation Resistance Tester

Single process to apply until ground bond test---

Example of system consisting TOS9201 and TOS6210

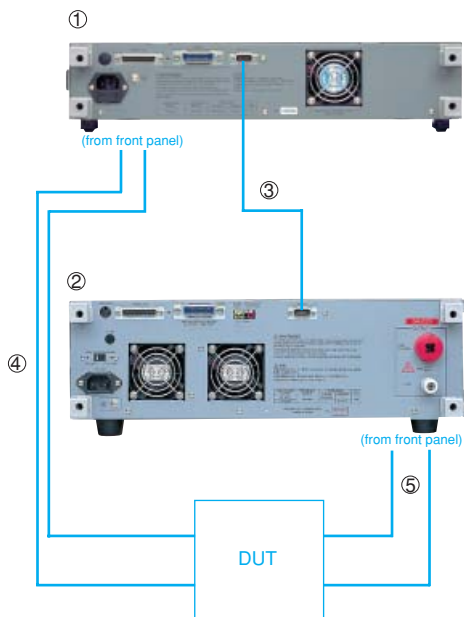

Item	Model	cable length	Required numbers
① Ground Bond Tester	TOS6210		1 pc.
② Hipot / Insulation Resistance Tester AC/DC	TOS9201		1 pc.
③ RS-232C Cross Cable (9pin female-9pin female)			1 pc.
④ Low-Voltage Test Lead	TL12-TOS	1.5m	1 set
⑤ High-Voltage Test Lead	TL01-TOS	1.5m *1	1 set

*1: Also available for 3m cable, TL02-TOS

[Rack mount bracket]

TOS9200 / 9201	(JIS)	KRB150-TOS
	(EIA)	KRB3-TOS
TOS6210 / 6200	(JIS)	KRB100-TOS
	(EIA)	KRB2-TOS

It is capable to perform for hipot / Insulation Resistance and Ground bond testing in one single process by controlling TOS6210 from TOS9201.

Fully Automated System by PC---

Example of system consisting TOS9201, TOS9221 (4CH) and TOS6210

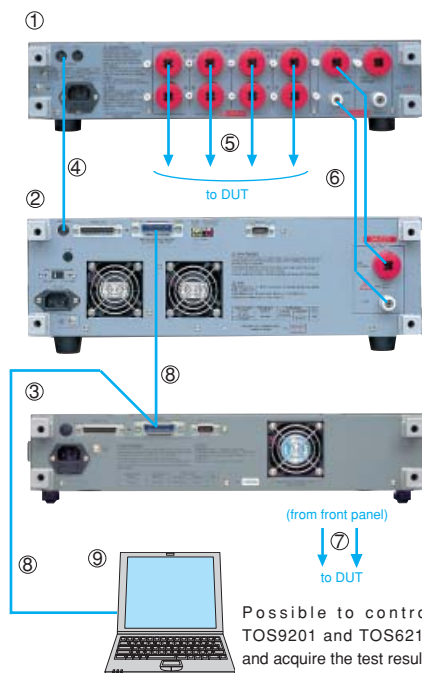

Item	Model	cable length	Required numbers
① High-Voltage Scanner	TOS9221		1 pc.
② Hipot / Insulation Resistance Tester AC/DC	TOS9201		1 pc.
③ Ground Bond Tester	TOS6210		1 pc.
④ Interface cable	85-50-0210	0.5m *1	1 pc.
⑤ High-Voltage Test Lead (red)	TL07-TOS	1.5m	4 pc.
⑥ High-Voltage Leads for Parallel connection	TL06-TOS	0.5m *2	1 set
⑦ Low-Voltage Test Lead	TL12-TOS	1.5m	1 set
⑧ GPIB Cable	408J-102	2m *3	2 pc.
⑨ PC (with GPIB Interface cable)			1 pc.

*1: Also available for 2m cable, DD2M-8P

*2: Also available for 1.5m cable, TL04-TOS

*3: Also available for 1m cable, 408J-101 and 4m cable, 408J-104

[Rack mount bracket]

TOS9200 / 9201	(JIS)	KRB150-TOS
	(EIA)	KRB3-TOS
TOS9220 / 9221 / 6210 / 6200	(JIS)	KRB100-TOS
	(EIA)	KRB2-TOS

[CAUTION] In case of use for combining more than 2sets of High Voltage Scanner unit and Ground Bond Tester, it is required to rack mount or locate these units to the side of Hipot / Insulation Resistance Tester, and it should not be piled up more than 2sets of High Voltage Scanner units.

TOS9200 SERIES

Hipot and Insulation Resistance Tester

Hipot test mode

Item	TOS9200	TOS9201		
Output section				
AC	Output-voltage range	0.05 kV to 5.00 kV AC		
	Resolution	10 V		
	Accuracy	±(1.5% of setting + 20 V) [with no load]		
	Maximum rated load (*1)	500 VA (5 kV/100 mA)		
	Maximum rated current	100 mA [output voltage of 0.2 kV or more]		
	Transformer capacity	500 VA		
	Output-voltage waveform(*2)	Sine wave		
	Distortion	2% or less [with no load or pure resistive load at output voltage of 0.5 kV or more applied]		
	Frequency	50 Hz/60 Hz		
	Accuracy	±0.1%		
	Voltage regulation	±3% or less [maximum rated load → no load]		
	Short-circuit current	200 mA or more, 350 mA or less [at output voltage of 0.5 kV or more]		
	Type of output	PWM switching		
DC	Output-voltage range	0.05 kV to 6.00 kV DC		
	Resolution	10 V		
	Accuracy	±(1.5% of the setting + 20 V)		
	Maximum rated load (*1)	50 W (5 kV/10 mA)		
	Maximum rated current	10 mA		
	Ripple	No load at 5 kV	50 Vp-p Typ.	
		Maximum rated load	150 Vp-p Typ.	
	Voltage regulation	1% or less [maximum rated load → no load]		
	Short-circuit current	40 mA Typ.		
	Discharge function	Forced discharge at the end of test(discharge resistance: 125 kΩ)		
Start voltage	The voltage at the start of the test can be set as the start voltage.			
Setting range	0% to 99% of the test voltage (resolution of 1%)			
Output-voltage monitoring function	If the output voltage exceeds ±(10% of the setting + 50 V), output is cut off and the protection function activates.			
Voltmeter				
Analog	Scale	6 kV AC/DC F.S		
	Accuracy	±5% F.S		
	Indicator	Mean-value responsive/root-mean-square value scale		
Digital	Measurement range	0.0 kV to 6.00 kV AC/DC		
	Resolution	10 V		
	Accuracy	±(1.0% of the reading + 30 V)		
	Response	Mean-value responsive/root-mean-square value display (response time of 200 ms)		
	HOLD function	The voltage measured at the end of test is held during the PASS and FAIL judgment time period.		

*1 Time limitation on output

The tester's hipot generator is designed to radiate half as much heat as the rated output, in consideration of the size, weight, cost, and other factors of the tester. It is therefore necessary to use the tester within the ranges specified below. Operations deviating from these ranges may heat the output section excessively, thereby activating the protective circuit. In such a case, suspend the test and wait until the temperature falls to the normal level.

[Output limitation in hipot testing (Output time = voltage rise time + test time + voltage fall time)]

Ambient temperature	Upper current	Pause Time	Output time
t ≤ 40 °C	AC	50 < i ≤ 110 mA	At least as long as the output time
		i ≤ 50 mA	Not necessary
	DC	5 < i ≤ 11 mA	At least as long as the output time
		i ≤ 5 mA	At least as long as the judgement wait time (WAIT TIME)

*2 Test-voltage waveform

When an AC test voltage is applied to a capacitive load, it is possible that the voltage becomes higher even than that when in the no load state. Furthermore, waveform distortion also may occur if the capacitance of the load is voltage-dependent (such as of ceramics capacitors). When the test voltage is not higher than 1.5 kV and the capacitance is not larger than 1000 pF, such test voltage changes are only of negligible levels. As the output type of the high-voltage generator block of the tester is PWM switching, switching noise and spike noise that the test voltage includes increase when the test voltage is 500 V or less. The lower the test voltage is, the more the waveform distortion increases.

Item	TOS9200	TOS9201								
Ammeter(*3)										
Measurement range	0.00 mA to 110 mA AC	0.00 mA to 110 mA AC/0.00 mA to 11 mA DC								
Display	<table border="1"> <tr> <td>i < 1 mA</td> <td>1 mA ≤ i < 10 mA</td> <td>10 mA ≤ i < 100 mA</td> <td>100 mA ≤ i</td> </tr> <tr> <td>□ □ □ μA</td> <td>□ □ □ mA</td> <td>□ □ □ mA</td> <td>□ □ □ mA</td> </tr> </table>	i < 1 mA	1 mA ≤ i < 10 mA	10 mA ≤ i < 100 mA	100 mA ≤ i	□ □ □ μA	□ □ □ mA	□ □ □ mA	□ □ □ mA	i = measured current
i < 1 mA	1 mA ≤ i < 10 mA	10 mA ≤ i < 100 mA	100 mA ≤ i							
□ □ □ μA	□ □ □ mA	□ □ □ mA	□ □ □ mA							
Accuracy	±(3% of the reading + 20 μA) [after the offset cancel function is activated, if the scanner is mounted]									
Response	Mean-value responsive / root-mean-square value display (response time of 200 ms)									
Hold function	The measured current at the end of the test is held during the PASS judgment time period.									
Offset cancel function	The current flowing to the insulation resistor between the output cables and the stray capacity is cancelled up to 100 μA/kV (in AC hipot testing only).									
Calibration	Performs calibration using the root-mean-square value of a sine wave with a pure resistive load									
Selection of LOW/GUARD for the GND (*4)	Selection permitted for current measurement between the mode for the GND point connected to the LOW terminal, and the mode using guard.									
	LOW	Connects the GND point to the LOW terminal. Measures the current flowing to the LOW terminal (chassis) (for normal operation).								
	GUARD	Sets the GND point as guard. Measures the current flowing to the LOW terminal, but does not measure the current flowing to the chassis (for high-sensitivity, high-accuracy measurements).								
Time										
Setting range for the voltage rise time (RISE TIME)	0.1 s to 200 s									
Setting range for the voltage fall time (FALL TIME)	0 s to 200 s (Valid only with PASS judgement)	0 s to 200 s (Valid only with PASS judgement in AC hipot testing)								
Setting range for the test time (TEST TIME)	0.3 s to 999 s With the TIMER OFF function									
Setting range for the judgement wait time (WAIT TIME)	0.3 s to 10 s (Only for DC hipot testing)	RISE TIME + TEST TIME > WAIT TIME								
Accuracy	± (100 ppm + 20 ms)									

TOS9200 SERIES

Hipot and Insulation Resistance Tester

Item	TOS9200	TOS9201																				
Judgement function																						
Judgement method/action	<table border="1"> <thead> <tr> <th>Judgement</th> <th>Judgement method</th> <th>Display</th> <th>Buzzer</th> <th>SIGNAL I/O</th> </tr> </thead> <tbody> <tr> <td>UPPER FAIL</td> <td>When the tester detects a current exceeding the upper current, it cuts off the output and makes an UPPER FAIL judgement. In DC hipot testing, however, no judgement is made until the judgement wait time (WIT TIME) has elapsed.</td> <td>The FAIL LED lights up. Displayed on the LCD</td> <td>ON</td> <td>Outputs the U FAIL signal</td> </tr> <tr> <td>LOWER FAIL</td> <td>When the tester detects a current below the lower current, it cuts off the output and makes a LOWER FAIL judgement. However, no judgement is made during the voltage rise time (RISE TIME) or voltage fall time (FALL TIME) in AC hipot testing.</td> <td>The FAIL LED lights up. Displayed on the LCD</td> <td>ON</td> <td>Outputs the L FAIL signal</td> </tr> <tr> <td>PASS</td> <td>When the preset time has elapsed without any abnormalities, the tester cuts off the output and makes a PASS judgement.</td> <td>The PASS LED lights up. Displayed on the LCD</td> <td>ON</td> <td>Outputs the PASS signal</td> </tr> </tbody> </table>	Judgement	Judgement method	Display	Buzzer	SIGNAL I/O	UPPER FAIL	When the tester detects a current exceeding the upper current, it cuts off the output and makes an UPPER FAIL judgement. In DC hipot testing, however, no judgement is made until the judgement wait time (WIT TIME) has elapsed.	The FAIL LED lights up. Displayed on the LCD	ON	Outputs the U FAIL signal	LOWER FAIL	When the tester detects a current below the lower current, it cuts off the output and makes a LOWER FAIL judgement. However, no judgement is made during the voltage rise time (RISE TIME) or voltage fall time (FALL TIME) in AC hipot testing.	The FAIL LED lights up. Displayed on the LCD	ON	Outputs the L FAIL signal	PASS	When the preset time has elapsed without any abnormalities, the tester cuts off the output and makes a PASS judgement.	The PASS LED lights up. Displayed on the LCD	ON	Outputs the PASS signal	
Judgement	Judgement method	Display	Buzzer	SIGNAL I/O																		
UPPER FAIL	When the tester detects a current exceeding the upper current, it cuts off the output and makes an UPPER FAIL judgement. In DC hipot testing, however, no judgement is made until the judgement wait time (WIT TIME) has elapsed.	The FAIL LED lights up. Displayed on the LCD	ON	Outputs the U FAIL signal																		
LOWER FAIL	When the tester detects a current below the lower current, it cuts off the output and makes a LOWER FAIL judgement. However, no judgement is made during the voltage rise time (RISE TIME) or voltage fall time (FALL TIME) in AC hipot testing.	The FAIL LED lights up. Displayed on the LCD	ON	Outputs the L FAIL signal																		
PASS	When the preset time has elapsed without any abnormalities, the tester cuts off the output and makes a PASS judgement.	The PASS LED lights up. Displayed on the LCD	ON	Outputs the PASS signal																		
	<ul style="list-style-type: none"> The PASS signal is output at the timing preset on PASS HOLD. If HOLD is set, the PASS signal is output continuously until the STOP signal is input. The UPPER FAIL signal and the LOWER FAIL signal are output continuously until the STOP signal is input. The FAIL and PASS buzzer volumes are adjustable. However, they cannot be adjusted individually, as they are set in common. 																					
Setting range for the upper current (UPPER)	0.01 mA to 110 mA AC	0.01 mA to 110 mA AC / 0.01 mA to 11 mA DC																				
Setting range for the lower current (LOWER)	0.01 mA to 110 mA AC (With the LOWER OFF function)	0.01 mA to 110 mA AC / 0.01 mA to 11 mA DC (With the LOWER OFF function)																				
Judgement accuracy (*3)	±(3% of setting + 20 µA) [After the offset cancel function is activated, if the scanner is mounted]																					
Current detection method	The absolute current values are integrated and compared with the reference value.																					
Response-speed switching function	The current-detection response speed for UPPER FAIL judgement can be set to FAST/MID/SLOW (for AC hipot testing only).																					

*3 In AC hipot testing, a current flows into the stray capacity of measurement leadwire and fixtures. When the optional high-voltage scanner TOS9220/9221 is used, a current of approximately 22 µA/kV flows into the stray capacity of each scanner. The table below shows the approximate currents flowing into such stray capacity. When the LOW terminal is set to GND, a current flowing into the stray capacity is added for measurement purposes to the current flowing into the DUT. In particular, for high-sensitivity, high-accuracy judgement, it is necessary to add the current flowing into the stray capacity to the lower/upper current. When the LOW terminal is set to FLOAT, the effect of the current flowing into the stray capacity is negligible. If the offset cancel function is used, the current flowing into the stray capacity can be eliminated from the measurement.

Output voltage	1kV	2kV	3kV	4kV	5kV
Hanging a 350-mm test lead wire (Typ. value)	2 µA	4 µA	6 µA	8 µA	10 µA
Using the accessory leadwire TL01-TOS (Typ. value)	16 µA	32 µA	48 µA	64 µA	80 µA
High-voltage scanner (Typ. value, not including the test leadwire)	22 µA	44 µA	66 µA	88 µA	110 µA

*4 With the GND set to GUARD, current measurement is disabled if the part of the DUT connected to the LOW terminal is grounded, which poses extreme danger. Never ground the DUT. In ordinary operation, set the GND to LOW.

Insulation Resistance Testing Mode

Item	TOS9200	TOS9201								
Output section										
Output-voltage range	-25 V to -1000 V DC									
Resolution	1 V									
Setting accuracy	±(1.5 % of Setting + 2 V)									
Maximum rated load	1 W (-1000 V DC/1 mA)									
Maximum rated current	1 mA									
Ripple	2 Vp-p or less									
1 kV no-load	10 Vp-p or less									
Maximum rated load	10 Vp-p or less									
Voltage regulation	1% or less [Maximum rated load → no load]									
Short-circuit current	12 mA or less									
Discharge function	Forced discharge at the end of test (discharge resistance : 25 kΩ)									
Output-voltage monitoring function	If the output voltage exceeds ±(10% of the setting + 50 V), output is cut off and the protection function activates.									
Voltmeter										
Analog	Scale	6 kV AC/DC F.S								
	Accuracy	±5% F.S								
	Indicator	Mean-value responsive / root-mean-square value scale								
Digital	Measurement range	0 V to -1200 V								
	Resolution	1 V								
	Accuracy	±(1 % of reading + 1 V)								
Resistance meter										
Measurement range	0.01 MΩ - 9.99 GΩ (Within the maximum rated current range of 1 mA to 50 nA)									
Display	<table border="1"> <thead> <tr> <th>R < 10.0 MΩ</th> <th>10.0MΩ ≤ R < 100.0MΩ</th> <th>100.0MΩ ≤ R < 1.00GΩ</th> <th>1.00GΩ ≤ R ≤ 9.99GΩ</th> </tr> </thead> <tbody> <tr> <td>□.□ □ MΩ</td> <td>□ □.□ MΩ</td> <td>□ □ □ MΩ</td> <td>□.□ □ GΩ</td> </tr> </tbody> </table>	R < 10.0 MΩ	10.0MΩ ≤ R < 100.0MΩ	100.0MΩ ≤ R < 1.00GΩ	1.00GΩ ≤ R ≤ 9.99GΩ	□.□ □ MΩ	□ □.□ MΩ	□ □ □ MΩ	□.□ □ GΩ	R = measured insulation resistance
R < 10.0 MΩ	10.0MΩ ≤ R < 100.0MΩ	100.0MΩ ≤ R < 1.00GΩ	1.00GΩ ≤ R ≤ 9.99GΩ							
□.□ □ MΩ	□ □.□ MΩ	□ □ □ MΩ	□.□ □ GΩ							
Accuracy	<table border="1"> <thead> <tr> <th>50 nA ≤ i ≤ 100 nA</th> <th>100 nA < i ≤ 200 nA</th> <th>200 nA < i ≤ 1 µA</th> <th>1 µA < i ≤ 1 mA</th> </tr> </thead> <tbody> <tr> <td>± (20 % of reading)</td> <td>± (10 % of reading)</td> <td>± (5 % of reading)</td> <td>± (2 % of reading)</td> </tr> </tbody> </table>	50 nA ≤ i ≤ 100 nA	100 nA < i ≤ 200 nA	200 nA < i ≤ 1 µA	1 µA < i ≤ 1 mA	± (20 % of reading)	± (10 % of reading)	± (5 % of reading)	± (2 % of reading)	i = measured current
50 nA ≤ i ≤ 100 nA	100 nA < i ≤ 200 nA	200 nA < i ≤ 1 µA	1 µA < i ≤ 1 mA							
± (20 % of reading)	± (10 % of reading)	± (5 % of reading)	± (2 % of reading)							
	[In the humidity range of 20 %rh to 70 %rh (no condensation), with no disturbance such as swinging of the test leadwire]									
Hold function	The measured current at the end of the test is held during the PASS period.									
Selection of LOW/GUARD for the GND (*5)	Selection permitted for current measurement between the mode for the GND point connected to the LOW terminal, and the mode using guard.									
	LOW	Connects the GND point to the LOW terminal. Measures the current flowing to the LOW terminal (chassis) (for normal operation).								
	GUARD	Sets the GND point as guard. Measures the current flowing to the LOW terminal, but does not measure the current flowing to the chassis (for high-sensitivity, high-accuracy measurements).								

TOS9200 SERIES

Hipot and Insulation Resistance Tester

Item	TOS9200	TOS9201																																																			
Judgement function																																																					
Judgement method/action	<table border="1"> <thead> <tr> <th>Judgement</th> <th>Judgement method</th> <th>Display</th> <th>Buzzer</th> <th>SIGNAL I/O</th> </tr> </thead> <tbody> <tr> <td>UPPER FAIL</td> <td>When the tester detects a resistance exceeding the upper cutoff resistance, it cuts off the output and makes an UPPER FAIL judgement. However, no judgement is made during a voltage rise time (RISE TIME).</td> <td>The FAIL LED lights up. Displayed on the LCD</td> <td>ON</td> <td>Outputs the U FAIL signal</td> </tr> <tr> <td>LOWER FAIL</td> <td>When the tester detects a resistance below the lower cutoff resistance, it cuts off the output and makes a LOWER FAIL judgement. However, no judgement is made until the judgement wait time (WAIT TIME) has elapsed.</td> <td>The FAIL LED lights up. Displayed on the LCD</td> <td>ON</td> <td>Outputs the L FAIL signal</td> </tr> <tr> <td>PASS</td> <td>When the preset time has elapsed without any abnormalities, the tester cuts off the output and makes a PASS judgement.</td> <td>The PASS LED lights up. Displayed on the LCD</td> <td>ON</td> <td>Outputs the PASS signal</td> </tr> </tbody> </table>	Judgement	Judgement method	Display	Buzzer	SIGNAL I/O	UPPER FAIL	When the tester detects a resistance exceeding the upper cutoff resistance, it cuts off the output and makes an UPPER FAIL judgement. However, no judgement is made during a voltage rise time (RISE TIME).	The FAIL LED lights up. Displayed on the LCD	ON	Outputs the U FAIL signal	LOWER FAIL	When the tester detects a resistance below the lower cutoff resistance, it cuts off the output and makes a LOWER FAIL judgement. However, no judgement is made until the judgement wait time (WAIT TIME) has elapsed.	The FAIL LED lights up. Displayed on the LCD	ON	Outputs the L FAIL signal	PASS	When the preset time has elapsed without any abnormalities, the tester cuts off the output and makes a PASS judgement.	The PASS LED lights up. Displayed on the LCD	ON	Outputs the PASS signal																																
Judgement	Judgement method	Display	Buzzer	SIGNAL I/O																																																	
UPPER FAIL	When the tester detects a resistance exceeding the upper cutoff resistance, it cuts off the output and makes an UPPER FAIL judgement. However, no judgement is made during a voltage rise time (RISE TIME).	The FAIL LED lights up. Displayed on the LCD	ON	Outputs the U FAIL signal																																																	
LOWER FAIL	When the tester detects a resistance below the lower cutoff resistance, it cuts off the output and makes a LOWER FAIL judgement. However, no judgement is made until the judgement wait time (WAIT TIME) has elapsed.	The FAIL LED lights up. Displayed on the LCD	ON	Outputs the L FAIL signal																																																	
PASS	When the preset time has elapsed without any abnormalities, the tester cuts off the output and makes a PASS judgement.	The PASS LED lights up. Displayed on the LCD	ON	Outputs the PASS signal																																																	
	<ul style="list-style-type: none"> The PASS signal is output at the timing preset on PASS HOLD. If HOLD is set, the PASS signal is output continuously until the STOP signal is input. The UPPER FAIL signal and the LOWER FAIL signal are output continuously until the STOP signal is input. The FAIL and PASS buzzer volumes are adjustable. However, they cannot be adjusted individually, as they are set in common. 																																																				
Setting range for the upper resistance (UPPER)	0.01 MΩ to 9.99 GΩ [Below the maximum rated current]																																																				
Setting range for the lower resistance (LOWER)	0.01 MΩ to 9.99 GΩ [Below the maximum rated current]																																																				
Judgement accuracy For both UPPER and LOWER	<table border="1"> <thead> <tr> <th>Judgement current</th> <th>50 nA ≤ i ≤ 100 nA</th> <th>100 nA < i ≤ 200 nA</th> <th>200nA < i ≤ 1 μA</th> <th>1 μA < i ≤ 1 mA</th> </tr> </thead> <tbody> <tr> <td>UPPER, LOWER</td> <td>0.01 ≤ R < 10.0 MΩ</td> <td>—</td> <td>—</td> <td>± (2 % of setting + 3digit)</td> </tr> <tr> <td></td> <td>10.0 ≤ R < 50.0 MΩ</td> <td>—</td> <td>—</td> <td>± (5 % of setting + 5digit)</td> </tr> <tr> <td></td> <td>50.0 ≤ R < 100 MΩ</td> <td>—</td> <td>—</td> <td>± (5 % of setting + 5digit)</td> </tr> <tr> <td></td> <td>100 MΩ ≤ R < 200 MΩ</td> <td>—</td> <td>± (10 % of setting + 5digit)</td> <td>± (2 % of setting + 3digit)</td> </tr> <tr> <td></td> <td>200 MΩ ≤ R < 500 MΩ</td> <td>± (20 % of setting + 5digit)</td> <td>± (10 % of setting + 5digit)</td> <td>± (5 % of setting + 5digit)</td> </tr> <tr> <td></td> <td>500 MΩ ≤ R < 1.00 GΩ</td> <td>± (20 % of setting + 5digit)</td> <td>± (10 % of setting + 5digit)</td> <td>± (2 % of setting + 3digit)</td> </tr> <tr> <td></td> <td>1.00 GΩ ≤ R < 2.00 GΩ</td> <td>± (20 % of setting + 10digit)</td> <td>± (10 % of setting + 5digit)</td> <td>—</td> </tr> <tr> <td></td> <td>2.00 GΩ ≤ R < 5.00 GΩ</td> <td>± (20 % of setting + 20digit)</td> <td>± (10 % of setting + 10digit)</td> <td>—</td> </tr> <tr> <td></td> <td>5.00 GΩ ≤ R < 10.0 GΩ</td> <td>± (20 % of setting + 20digit)</td> <td>± (10 % of setting + 10digit)</td> <td>—</td> </tr> </tbody> </table> <p>Judgement current = test voltage/(UPPER,LOWER)</p> <p>[In the humidity range of 20 %rh to 70 %rh (no condensation), with no disturbance such as swinging of the test leadwire] [In LOWER judgement, at least 0.5 s is necessary for testing after the WAIT TIME has elapsed. In LOWER judgement for 200 nA or lower, a wait time of at least 1.0 s is necessary.]</p>			Judgement current	50 nA ≤ i ≤ 100 nA	100 nA < i ≤ 200 nA	200nA < i ≤ 1 μA	1 μA < i ≤ 1 mA	UPPER, LOWER	0.01 ≤ R < 10.0 MΩ	—	—	± (2 % of setting + 3digit)		10.0 ≤ R < 50.0 MΩ	—	—	± (5 % of setting + 5digit)		50.0 ≤ R < 100 MΩ	—	—	± (5 % of setting + 5digit)		100 MΩ ≤ R < 200 MΩ	—	± (10 % of setting + 5digit)	± (2 % of setting + 3digit)		200 MΩ ≤ R < 500 MΩ	± (20 % of setting + 5digit)	± (10 % of setting + 5digit)	± (5 % of setting + 5digit)		500 MΩ ≤ R < 1.00 GΩ	± (20 % of setting + 5digit)	± (10 % of setting + 5digit)	± (2 % of setting + 3digit)		1.00 GΩ ≤ R < 2.00 GΩ	± (20 % of setting + 10digit)	± (10 % of setting + 5digit)	—		2.00 GΩ ≤ R < 5.00 GΩ	± (20 % of setting + 20digit)	± (10 % of setting + 10digit)	—		5.00 GΩ ≤ R < 10.0 GΩ	± (20 % of setting + 20digit)	± (10 % of setting + 10digit)	—
Judgement current	50 nA ≤ i ≤ 100 nA	100 nA < i ≤ 200 nA	200nA < i ≤ 1 μA	1 μA < i ≤ 1 mA																																																	
UPPER, LOWER	0.01 ≤ R < 10.0 MΩ	—	—	± (2 % of setting + 3digit)																																																	
	10.0 ≤ R < 50.0 MΩ	—	—	± (5 % of setting + 5digit)																																																	
	50.0 ≤ R < 100 MΩ	—	—	± (5 % of setting + 5digit)																																																	
	100 MΩ ≤ R < 200 MΩ	—	± (10 % of setting + 5digit)	± (2 % of setting + 3digit)																																																	
	200 MΩ ≤ R < 500 MΩ	± (20 % of setting + 5digit)	± (10 % of setting + 5digit)	± (5 % of setting + 5digit)																																																	
	500 MΩ ≤ R < 1.00 GΩ	± (20 % of setting + 5digit)	± (10 % of setting + 5digit)	± (2 % of setting + 3digit)																																																	
	1.00 GΩ ≤ R < 2.00 GΩ	± (20 % of setting + 10digit)	± (10 % of setting + 5digit)	—																																																	
	2.00 GΩ ≤ R < 5.00 GΩ	± (20 % of setting + 20digit)	± (10 % of setting + 10digit)	—																																																	
	5.00 GΩ ≤ R < 10.0 GΩ	± (20 % of setting + 20digit)	± (10 % of setting + 10digit)	—																																																	
Time																																																					
Setting range for the voltage rise time (RISE TIME)	0.1 s to 200 s																																																				
Setting range for the test time (TEST TIME)	0.5 s to 999 s With the TIMER OFF function																																																				
Setting range for the judgement wait time (WAIT TIME)	0.3 s to 10 s [RISE TIME + TEST TIME > WAIT TIME]																																																				
Accuracy	± (100 ppm + 20 ms)																																																				

*5 When the GND is set to GUARD, current measurement is disabled if the part of the DUT connected to the LOW terminal is grounded, which poses extreme danger. Never ground the DUT.
In ordinary operation, set the GND to LOW.

General Specifications

Item	TOS9200	TOS9201
Environment		
Installation location	Indoors at an altitude of up to 2000 m	
Warranty range	Temperature	5 °C to 35 °C
	Humidity	20 %rh to 80 %rh (No condensation)
Operating range	Temperature	0 °C to 40 °C
	Humidity	20 %rh to 80 %rh (No condensation)
Storage range	Temperature	-20 °C to 70 °C
	Humidity	90 %rh or less (No condensation)
Power requirements		
Nominal voltage range (Allowable voltage range)	100 V to 120 V AC / 200 V to 240 V AC (85 V to 130 V AC / 170 V to 250 V AC) Selectable	
Power consumption	Using no load (READY)	100 VA or less
	Using the rated load	Maximum of 800 VA
Allowable frequency range	47 Hz to 63 Hz	
Insulation resistance	30 MΩ or more (500 V DC) [between the AC LINE and chassis]	
Hipot	1390 V AC, 2 seconds, 20 mA or less [between the AC LINE and chassis]	
Ground bond	25 A AC/0.1 Ω or less	
Electromagnetic compatibility (EMC) (*6)	Conforms to the requirements of the following directive and standard. EMC Directive 89/336/EEC, EN61326, EN61000-3-2, EN61000-3-3 Under following conditions 1. Used test leadwire TL01-TOS which is supplied. 2. No discharge occurs at outside of the tester. 3. Used the shielded cable which length is less than three meters when the SIGNAL I/O is used.	
Safety (*6,7)	Conforms to the requirements of the following directive and standard. Low Voltage Directive 73/23/EEC, EN61010-1, Class I, Pollution degree 2	
Dimensions (maximum)	430 (455) W x 132 (150) H x 370 (440) D mm	
Weight	Approx. 19 kg	

TOS9200 SERIES

Hipot and Insulation Resistance Tester

Item	TOS9200	TOS9201
Accessory		
AC Power cable	1 pc.	
High-voltage test lead wire TL01-TOS (1.5 m)	1 set	
Interlock jumper	1 pc.	
High-Voltage Danger seal	1 sheet	
Fuse	1 pc.	
Operation Manual	Operation Manual for Tester: 1 copy, Operation for GPIB/RS-232C Interface: 1 copy	

*6 Only on models that have CE marking on the panel. Not applicable to custom order models.

*7 This instrument is a Class I equipment. Be sure to ground the protective conductor terminal of the instrument. The safety of the instrument is not guaranteed unless the instrument is grounded properly.

Electrical performance

Item	TOS9200	TOS9201
Maximum rating voltage	AC DC	5.0 kV 6.0 kV
Number of channels	4 (Each channel is settable to HIGH, LOW, or OPEN.)	
Maximum number of scanners connected	4 scanners, Channel numbers are determined in order of connection to the TOS9200/9201 tester. 1 st scanner CH1 to CH4 2 nd scanner CH5 to CH8 3 rd scanner CH9 to CH12 4 th scanner CH13 to CH16	
Contact check function	None (*1)	Provided
Lamps and LEDs	POWER DANGER CHANNEL	Lights as it is interlocked with the POWER switch of the TOS9200/9201 tester Lights as it is interlocked with the DANGER lamp of the TOS9200/9201 tester Lights during a test at each channel HIGH: red; LOW: green; Under contact check: orange
Power requirements		
Nominal voltage range (allowable voltage range)	100 V to 120 V AC/200 V to 240 V AC (85 V to 132 V AC/170 V to 250 V AC) Automatic switching	
Power consumption	In READY state During test	Approx. 12 VA 40 VA maximum
Allowable frequency range	47 Hz to 63 Hz	
Insulation resistance	30 M Ω or more (500 V DC) [between the AC LINE and chassis]	
Hipot	1390 V AC, 2 seconds, 10 mA or less [between the AC LINE and chassis]	
Ground bond	25 A AC/0.1 Ω or less	
Electromagnetic compatibility (EMC) (*2)	Conforms to the requirements of the following directive and standard. EMC Directive 89/336/EEC, EN61326, EN61000-3-2, EN61000-3-3 Under following conditions 1. Used test leadwire TL07-TOS which is supplied. 2. No discharge occurs at outside of the tester. 3. Used the shielded cable which length is less than three meters when the SIGNAL I/O is used.	
Safety (*2,3)	Conforms to the requirements of the following directive and standard. Low Voltage Directive 73/23/EEC, EN61010-1, Class I, Pollution degree 2	
Environment		
Installation location	Indoors and at altitudes up to 2000 m	
Warranty range	Temperature Humidity	5 °C to 35 °C 20 %rh to 80 %rh (no condensation)
Operating range	Temperature Humidity	0 °C to 40 °C 20 %rh to 80 %rh (no condensation)
Storage range	Temperature Humidity	-20 °C to 70 °C 90 %rh or less (no condensation)
Dimensions	430(435)W × 88(105)H × 370(415) Dmm	
Weight	Approx. 6.5 kg	
Accessories		
AC power cable	1 pc.	
High-voltage test leadwires, red	4 pc. (1.5 m each)	8 pc. (1.5 m each)
High-voltage leads for parallel connection	1 set (0.5 m each)	
Interface cable	1 pc.(0.5 m)	
Channel-indication stickers	For the panel face: 1 sheet; for the test leadwires: 1	
“HIGH VOLTAGE, DANGER” stickers	2 sheets	
Fuses	2 pc. (including a spare contained in the fuse holder)	
Operation Manual	1 copy	

*2 Only on models that have CE marking on the panel. Not applicable to custom order models.

*3 This instrument is a Class I equipment. Be sure to ground the protective conductor terminal of the instrument. The safety of the instrument is not guaranteed unless the instrument is grounded properly.

[Measurement accuracy achieved when the scanner and the TOS9220/9201 tester are connected]

In an AC hipot test, a current of approx. 22 μA/kV flows per scanner due to stray capacitance in the scanner in comparison with use of the TOS9220/9201 tester alone. Note that this current may contribute to errors in current measurements conducted by the TOS9220/9201 tester.

External dimensional diagrams

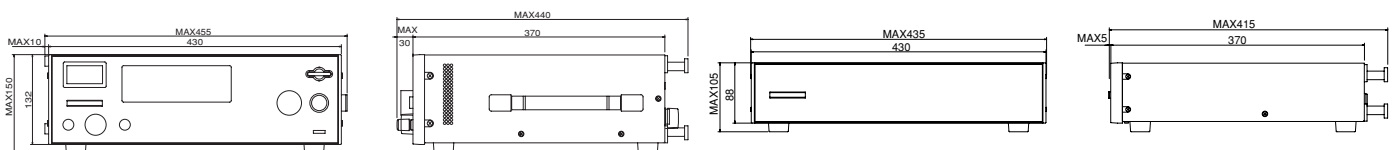

Unit: mm



KIKUSUI ELECTRONICS CORPORATION

1-1-3, Higashiyamata, Tsuzuki-ku, Yokohama, 224-0023, Japan
Phone: (+81) 45-593-7570, Facsimile: (+81) 45-593-7571, www.kikusui.co.jp

KIKUSUI AMERICA, INC. Toll Free **1-800-KIKUSUI** www.kikusui.us



1744 Rollins Road, Burlingame, CA 94010
Phone : 650-259-5900 Facsimile : 650-259-5904

KIKUSUI TRADING (SHANGHAI) Co., Ltd. www.kikusui.cn



Room, D-01,11F, Majesty Bld, No.138, Pudong Ave, Shanghai City
Phone : 021-5887-9067 Facsimile : 021-5887-9069

For our local sales distributors and representatives, please refer to "sales network" of our website.

Recycled Paper

●Distributor:

■ All products contained in this catalogue are equipment and devices that are premised on use under the supervision of qualified personnel, and are not designed or produced for home-use or use by general consumers. ■ Specifications, design and so forth are subject to change without prior notice to improve the quality. ■ Product names and prices are subject to change and production may be discontinued when necessary. ■ Product names, company names and brand names contained in this catalogue represent the respective registered trade name or trade mark. ■ Colors, textures and so forth of photographs shown in this catalogue may differ from actual products due to a limited fidelity in printing. ■ Although every effort has been made to provide the information as accurate as possible for this catalogue, certain details have unavoidably been omitted due to limitations in space. ■ If you find any misprints or errors in this catalogue, it would be appreciated if you would inform us. ■ Please contact our distributors to confirm specifications, price, accessories or anything that may be unclear when placing an order or concluding a purchasing agreement.

Printed in Japan

Issue:Feb.2008

2008021KCMEC41